

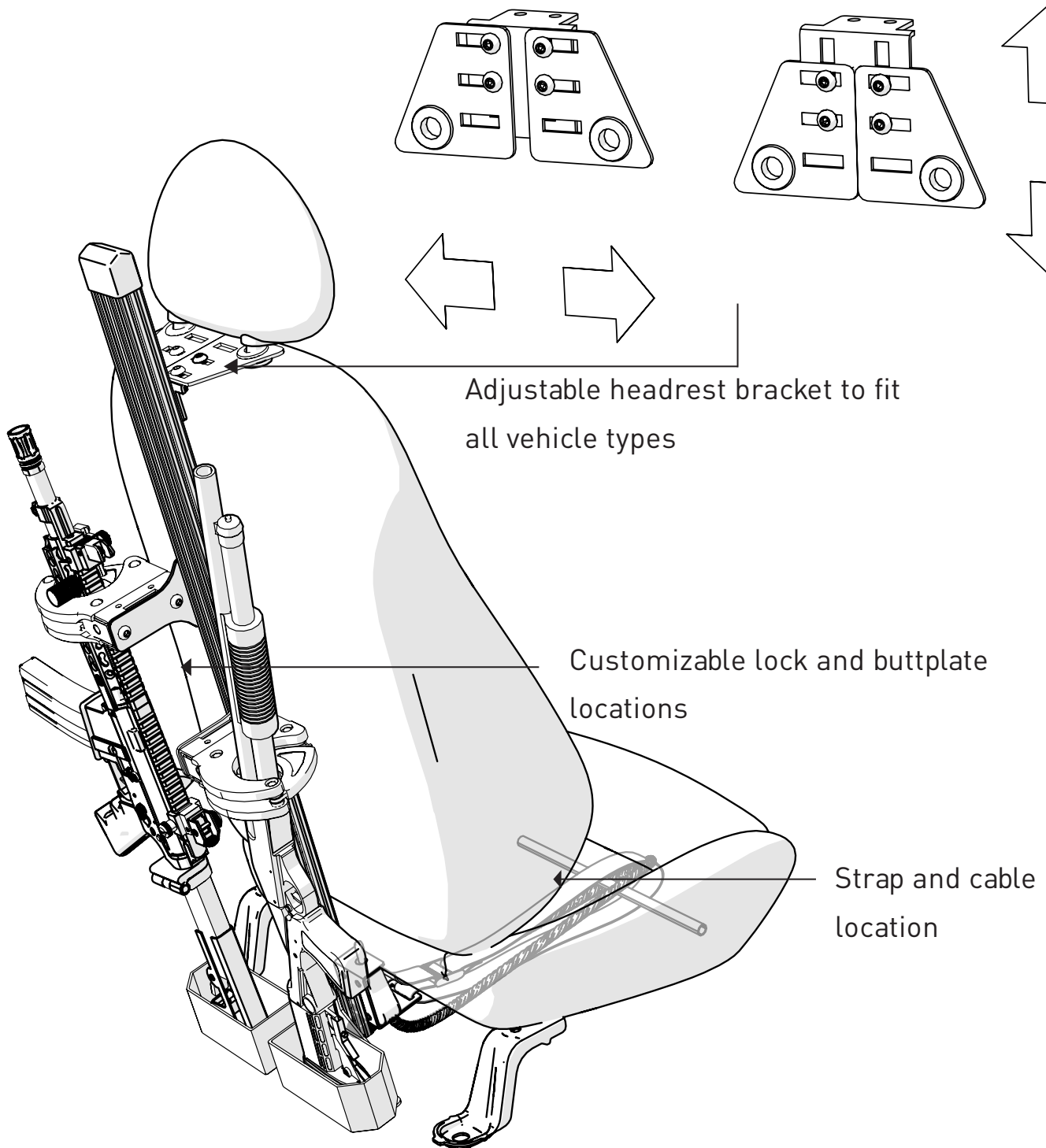

**WEISER
SOLUTIONS**



WEI-004-HR

How to Install

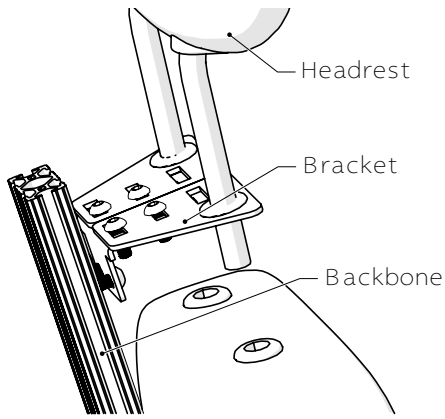

1. Remove the headrest from the seat.
2. Insert the headrest to the holes of the bracket and tighten the screws.
3. Fasten the headrest bracket to the backbone. Make sure there is at least 1inch of allowance from the top of backbone
4. Put the headrest back on.

5. Fasten the cable lock bracket to the backbone.
6. Insert the strap to the lock bracket and pass the end of the buckle around a metal part underneath the seat. To thread a cam buckle, feed the strap back through while pressing the thumb release and pull the strap to your desired tension.

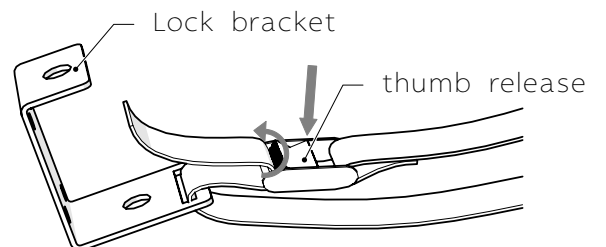
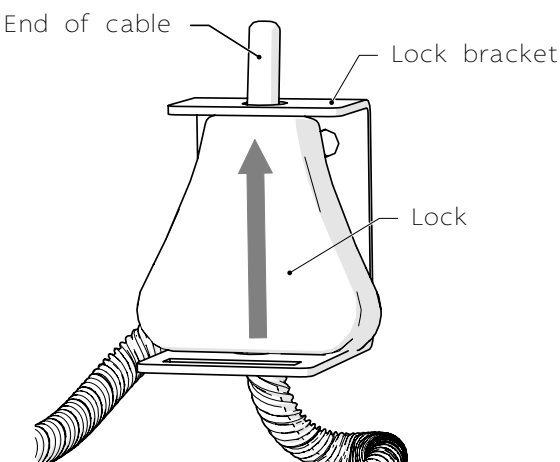
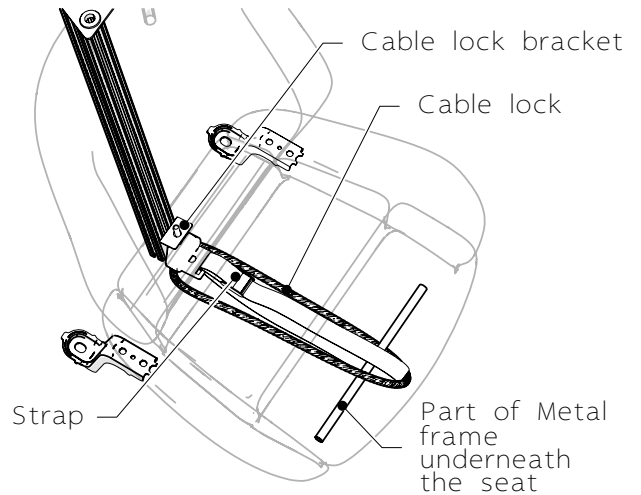

7. Put the lock in the bracket. Pass the end of the cable around a metal part same with the strap. Insert the end of the cable to bottom hole of the bracket through the lock up to the top hole of the bracket

8. After securing the lock and tightening screws in the bracket, choose your desired or custom configuration then insert the weapon lock and buttplate.

